

#### Features

- 9" (229 mm) spout reach
- 2-7/8" (73 mm) high nondiverter spout
- KOHLER ceramic disc valves exceed industry longevity standards for a lifetime of durable performance
- Variety of handle style options (sold separately)
- Handle trim sold separately
- Coordinates with other products in the Artifacts collection

#### Material

- Brass
- KOHLER finishes resist corrosion and tarnishing

#### Installation

- Finished deck-mount installation only

#### Included Components

Additional Components:  
1354692



#### Codes/Standards







ASME A112.18.1/CSA B125.1

#### KOHLER® Faucet Lifetime Limited Warranty

See website for detailed warranty information.

#### Available Colors/Finishes

*Color tiles intended for reference only.*

Color	Code	Description
	CP	Polished Chrome
	SN	Vibrant™ Polished Nickel
	BN	Vibrant™ Brushed Nickel
	BV	Vibrant™ Brushed Bronze
	2BZ	Oil-Rubbed Bronze
	2MB	Vibrant™ Brushed Moderne Brass

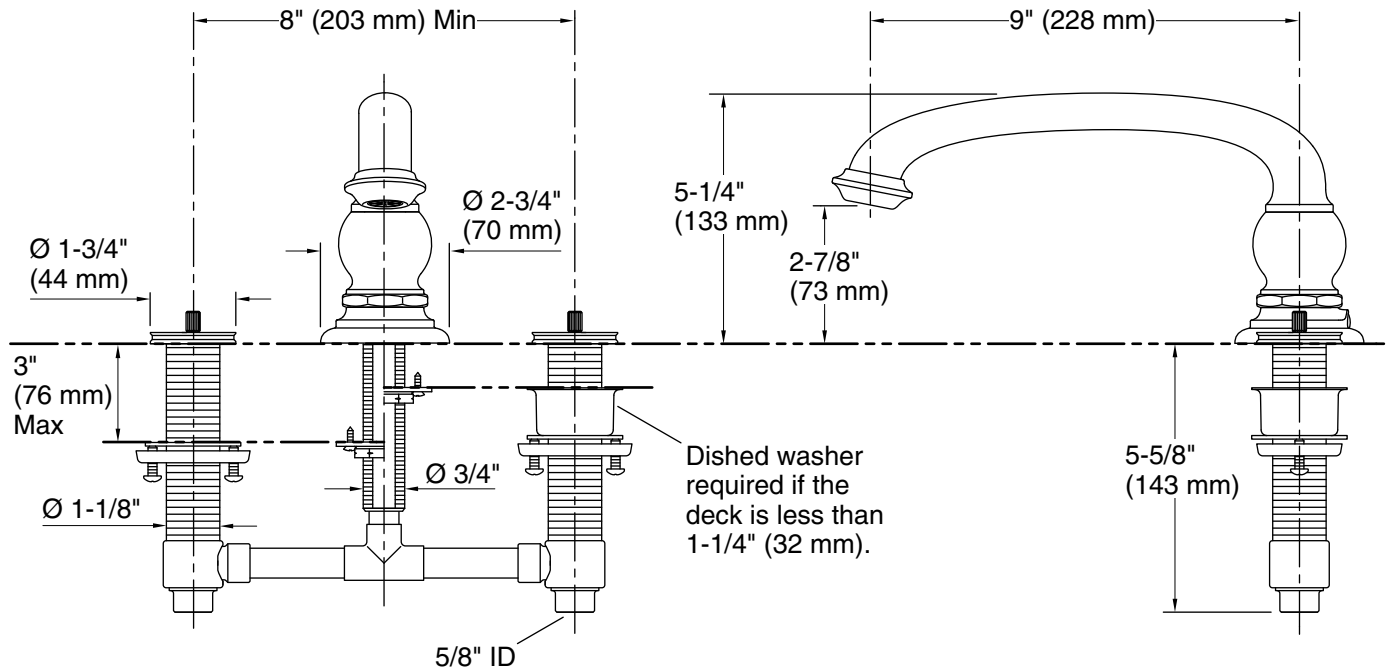

### Technical Information

All product dimensions are nominal.

#### Spout:

Spout reach: 9" (229 mm)

### Notes

**IMPORTANT!** Artifacts deck-mount handles are only compatible with the valve included with the Artifacts deck-mount faucets. Do not install to a K-300 bath valve.

**IMPORTANT!** For K-T98071-9M models, the handle swings up and toward the user. Ensure that the handle will not interfere with the bath fixture during operation.

Install this product according to the installation guide.

For a finished bath deck/rim less than 5/8" (16 mm) thick: Install wood reinforcing material to the underside of the deck/rim. The combined thickness of the reinforcing material and the deck/rim must not exceed 3" (76 mm).